

#16511

ASSEMBLY INSTRUCTION - BIN RACK

A-4 pcs

Poles



B-28 pairs

Slip Sleeves

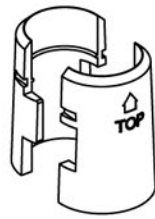

C-2 pairs

Wheels

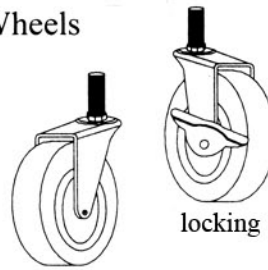

D-7 pcs

Shelves

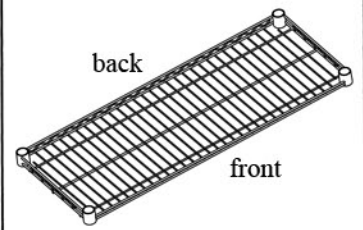

E-22 pcs

Storage Bins

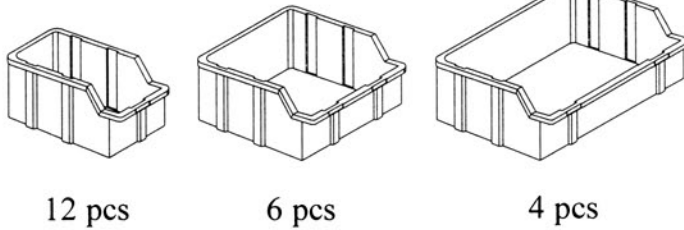

12 pcs

6 pcs

4 pcs

F-30 pcs

Bin Labels

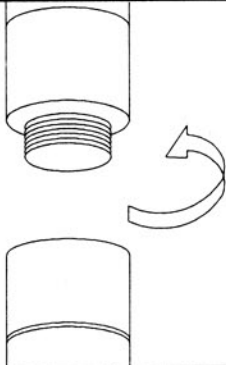
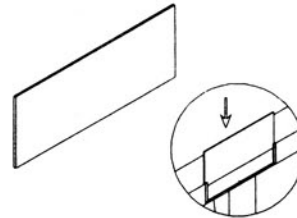

①

Step 1

Screw the top and bottom **Poles (A)** together.

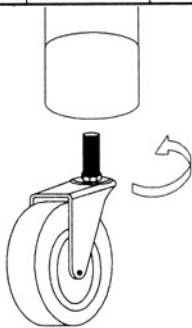

②

Step 2

Screw the **Wheels (C)** into the bottom end of each pole.

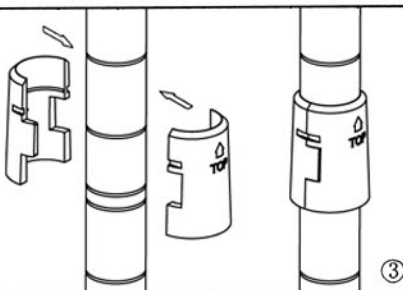

③

Step 3

Starting at the bottom, fasten a pair of **Slip Sleeves (B)** around the groove of each pole. If necessary, move the sleeves slightly up or down until it “snaps” into place.

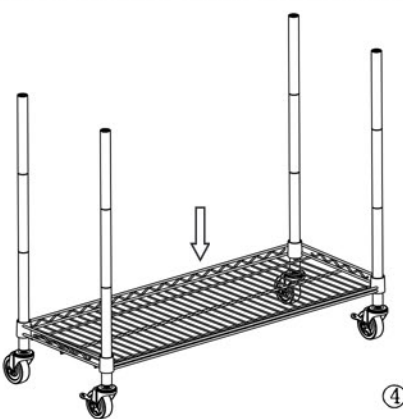

④

Step 4

Slide a **Shelf (D)** over the top of the 4 poles until it rests snugly over the sleeves. The one side without retainer faces the front. Repeat for 6 more shelves.

Tip: If necessary, use a rubber mallet to further secure the shelf.

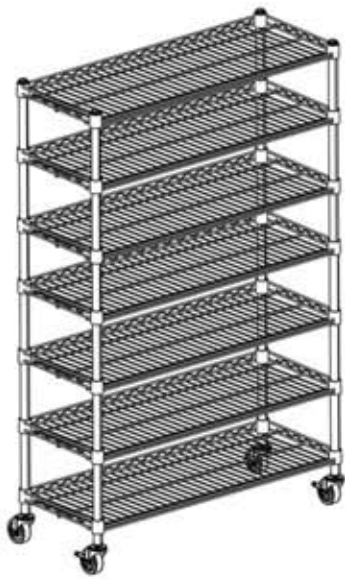

⑤

Step 5

Slide the **Bins (E)** onto the shelves. Place the **Bin Labels (F)** in the label slots.

